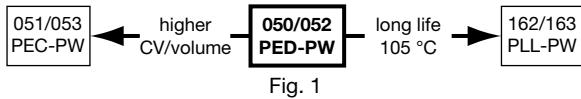


Aluminum Electrolytic Capacitors Power Eurodin Printed Wiring


FEATURES

- Very long useful life: 15 000 h at 85 °C
- Low ESR, high ripple current capability
- High resistance to shock and vibration
- Polarized aluminum electrolytic capacitors, non-solid electrolyte
- Large types, cylindrical aluminum case, insulated with a blue sleeve
- Provided with keyed polarity
- 050 series also available in solder-lug (SL) versions
- Material categorization: for definitions of compliance please see www.vishay.com/doc?99912


**RoHS
COMPLIANT**
APPLICATIONS

- Computer, telecommunication, and industrial systems
- Smoothing and filtering
- Standard and switched mode power supplies
- Energy storage in pulse systems

MARKING

The capacitors are marked (where possible) with the following information:

- Rated capacitance (in μF)
- Tolerance on rated capacitance, code letter in accordance with IEC 60062 (Q for -10 % / +30 %)
- Rated voltage (in V)
- Date code (YYWW or in 2 digits according to IEC 60062)
- Name of manufacturer
- Code for factory of origin
- Polarity of the terminals and “-” sign to indicate the negative terminal, visible from the top and / or side of the capacitor
- Code number
- Climatic category in accordance with IEC 60068

QUICK REFERENCE DATA		
DESCRIPTION	VALUE	
	050	052
Nominal case size ($\varnothing D \times L$ in mm)	25 x 30 to 40 x 100	
Rated capacitance range (E6 series), C_R	470 μF to 68 000 μF	47 μF to 1000 μF
Tolerance on C_R	-10 % to +30 %	
Rated voltage range, U_R	10 V to 100 V	250 V to 400 V
Category temperature range	-40 °C to +85 °C	
Endurance test at 85 °C	5000 h	
Useful life at 85 °C	15 000 h	
Useful life at 40 °C, 1.4 x I_R applied	250 000 h	
Shelf life at 0 V, 85 °C	500 h	
Based on sectional specification	IEC 60384-4 / EN 130300	
Climatic category IEC 60068	40 / 085 / 56	

SELECTION CHART FOR C_R , U_R , AND RELEVANT NOMINAL CASE SIZES FOR 050 SERIES ($\varnothing D \times L$ in mm)						
C_R (μF)	U_R (V)					
	10	16	25	40	63	100
470	-	-	-	-	-	25 x 30
680	-	-	-	-	-	25 x 40
1000	-	-	-	-	25 x 30	30 x 40
1500	-	-	-	25 x 30	25 x 40	35 x 40
2200	-	-	25 x 30	25 x 40	30 x 40	35 x 50
3300	-	25 x 30	25 x 40	30 x 40	35 x 40	40 x 50
4700	25 x 30	25 x 40	30 x 40	35 x 40	35 x 50	40 x 70
6800	25 x 40	30 x 40	35 x 40	35 x 50	40 x 50	40 x 100
10 000	30 x 40	35 x 40	35 x 50	40 x 50	40 x 70	-
15 000	35 x 40	35 x 50	40 x 50	40 x 70	40 x 100	-
22 000	35 x 50	40 x 50	40 x 70	40 x 100	-	-
33 000	40 x 50	40 x 70	40 x 100	-	-	-
47 000	40 x 70	40 x 100	-	-	-	-
68 000	40 x 100	-	-	-	-	-

SELECTION CHART FOR C_R, U_R, AND RELEVANT NOMINAL CASE SIZES FOR 052 SERIES ($\varnothing D \times L$ in mm)			
C_R (μF)	U_R (V)		
	250	385	400
47	-	25 x 30	25 x 30
68	-	25 x 40	25 x 40
100	25 x 30	30 x 40	30 x 40
150	25 x 40	35 x 40	35 x 40
220	30 x 40	35 x 50	35 x 50
	-	40 x 40	40 x 40
330	35 x 40	40 x 50	40 x 50
470	35 x 50	40 x 70	40 x 70
	40 x 40	-	-
680	40 x 50	-	40 x 100
1000	40 x 70	-	-

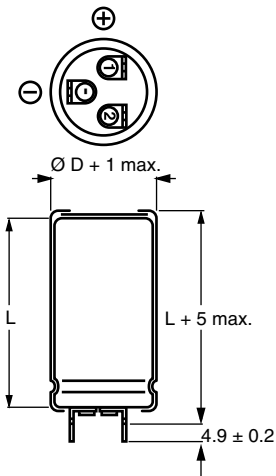
DIMENSIONS in millimeters AND AVAILABLE FORMS

 Case $\varnothing D = 25$ mm

Fig. 2 - Printed wiring pin version

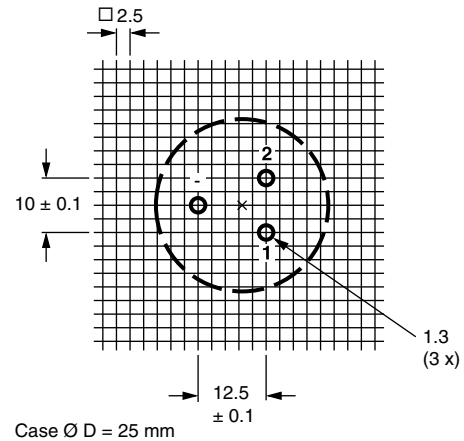


Fig. 3 - Mounting hole diagram viewed from component side

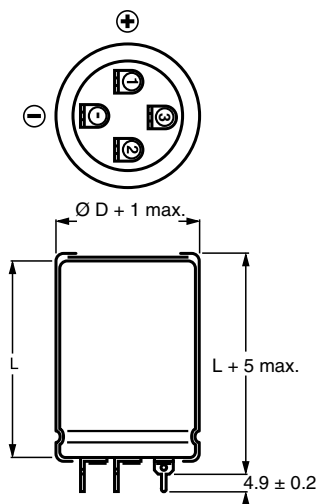

 Case $\varnothing D = 30$ mm

Fig. 4 - Printed wiring pin version

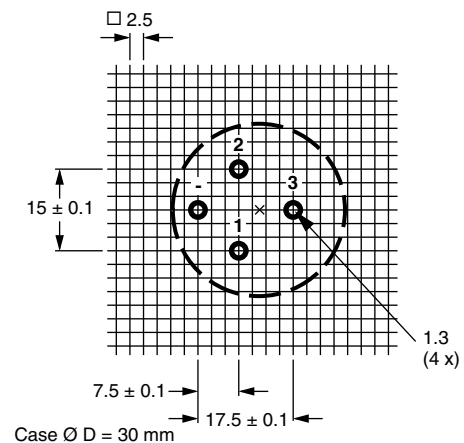


Fig. 5 - Mounting hole diagram viewed from component side



Fig. 6 - Printed wiring pin version



Fig. 7 - Mounting hole diagram viewed from component side



Fig. 8 - Printed wiring pin version



Fig. 9 - Mounting hole diagram viewed from component side



Fig. 10 - Solder-lug versions (SL): only available in 050 series

MOUNTING

When a number of capacitors are connected in a bank, they must not be closer together than 15 mm, when no derating of ripple current and / or temperature is applied.

Pin number 1 is the positive terminal. Pin “-” is the negative terminal.

Pin numbers 2, 3 and 4 (if present) should be free from the electrical circuit or connected to the minus terminal.



Table 1

DIMENSIONS in millimeters, MASS, AND PACKAGING QUANTITIES						
NOMINAL CASE SIZE Ø D x L	Ø D _{max.}	L _{max.} SL VERSIONS	L _{max.} PW VERSIONS	MASS (g)	PACKAGING QUANTITIES (units per box)	CARDBOARD BOX DIMENSIONS L x W x H
25 x 30	26	32	35	≈ 24	100	290 x 280 x 50
25 x 40	26	42	45	≈ 28	100	290 x 280 x 60
30 x 40	31	42	45	≈ 38	100	340 x 330 x 60
35 x 40	36	42	45	≈ 51	50	390 x 198 x 60
35 x 50	36	52	55	≈ 66	50	390 x 198 x 70
40 x 40 ⁽¹⁾	41	-	45	≈ 78	50	440 x 223 x 60
40 x 50	41	52	55	≈ 82	50	440 x 223 x 70
40 x 70	41	72	75	≈ 110	25	230 x 230 x 90
40 x 100	41	102	105	≈ 176	25	230 x 230 x 120

Note

⁽¹⁾ Not available in SL versions

ELECTRICAL DATA	
SYMBOL	DESCRIPTION
C _R	Rated capacitance at 100 Hz
I _R	Rated RMS ripple current at 100 Hz, 85 °C or at 20 kHz, 70 °C
I _{L1}	Max. leakage current after 1 min at U _R
I _{L5}	Max. leakage current after 5 min at U _R
ESR	Max. equivalent series resistance at 100 Hz
Z	Max. impedance at 10 kHz

Note

- Unless otherwise specified, all electrical values in tables 2 and 3 apply at T_{amb} = 20 °C, P = 86 kPa to 106 kPa, RH = 45 % to 75 %

ORDERING EXAMPLE

Electrolytic capacitor 050 series
 10 000 µF / 25 V; -10 % / +30 %
 Nominal case size: Ø 35 mm x 50 mm; PW version
 Ordering code: MAL2 050 56103 E3
 Former 12NC: 2222 050 56103

Table 2

ELECTRICAL DATA AND ORDERING INFORMATION FOR 050 SERIES										
U _R (V)	C _R 100 Hz (µF)	NOMINAL CASE SIZE Ø D x L (mm)	I _R 100 Hz 85 °C (A)	I _R 20 kHz 70 °C (A)	I _{L1} 1 min (mA)	I _{L5} 5 min (mA)	ESR 100 Hz (mΩ)	Z 10 kHz (mΩ)	ORDERING CODE SL MAL2050.....	ORDERING CODE PW MAL2050.....
10	4700	25 x 30	2.4	4.6	0.28	0.10	74	50	14472E3	54472E3
	6800	25 x 40	3.2	6.1	0.41	0.14	51	37	14682E3	54682E3
	10 000	30 x 40	3.8	7.2	0.60	0.20	39	29	14103E3	54103E3
	15 000	35 x 40	4.1	7.8	0.90	0.30	35	26	14153E3	54153E3
	22 000	35 x 50	5.0	9.5	1.32	0.44	27	21	14223E3	54223E3
	22 000	40 x 40	4.2	8.0	1.32	0.44	36	27	n/a	44223E3
	33 000	40 x 50	5.0	9.5	1.98	0.66	29	22	14333E3	54333E3
	47 000	40 x 70	6.8	12.9	2.82	0.94	20	17	14473E3	54473E3
	68 000	40 x 100	9.2	17.5	4.08	1.36	15	14	14683E3	54683E3



ELECTRICAL DATA AND ORDERING INFORMATION FOR 050 SERIES										
U _R (V)	C _R 100 Hz (μF)	NOMINAL CASE SIZE Ø D x L (mm)	I _R 100 Hz 85 °C (A)	I _R 20 kHz 70 °C (A)	I _{L1} 1 min (mA)	I _{L5} 5 min (mA)	ESR 100 Hz (mΩ)	Z 10 kHz (mΩ)	ORDERING CODE SL MAL2050.....	ORDERING CODE PW MAL2050.....
16	3300	25 x 30	2.4	4.6	0.32	0.11	75	50	15332E3	55332E3
	4700	25 x 40	3.1	5.9	0.45	0.15	52	37	15472E3	55472E3
	6800	30 x 40	3.7	7.0	0.65	0.22	40	30	15682E3	55682E3
	10 000	35 x 40	4.1	7.8	0.96	0.32	36	27	15103E3	55103E3
	15 000	35 x 50	5.0	9.5	1.44	0.48	28	21	15153E3	55153E3
	15 000	40 x 40	4.2	8.0	1.44	0.48	36	27	n/a	45153E3
	22 000	40 x 50	5.0	9.5	2.12	0.71	29	22	15223E3	55223E3
	33 000	40 x 70	6.7	12.7	3.17	1.06	20	17	15333E3	55333E3
47 000	40 x 100	9.1	17.3	4.51	1.51	15	14	15473E3	55473E3	
25	2200	25 x 30	2.3	4.4	0.33	0.11	78	52	16222E3	56222E3
	3300	25 x 40	3.1	5.9	0.49	0.17	53	38	16332E3	56332E3
	4700	30 x 40	3.7	7.0	0.70	0.24	42	31	16472E3	56472E3
	6800	35 x 40	4.1	7.8	1.02	0.34	37	28	16682E3	56682E3
	10 000	35 x 50	5.0	9.5	1.50	0.50	28	21	16103E3	56103E3
	10 000	40 x 40	4.2	8.0	1.50	0.50	36	27	n/a	46103E3
	15 000	40 x 50	5.0	9.5	2.25	0.75	29	22	16153E3	56153E3
	22 000	40 x 70	6.8	12.9	3.30	1.10	20	17	16223E3	56223E3
33 000	40 x 100	9.2	17.5	4.95	1.65	15	14	16333E3	56333E3	
40	1500	25 x 30	2.0	3.8	0.36	0.12	112	68	17152E3	57152E3
	2200	25 x 40	2.7	5.1	0.53	0.18	76	51	17222E3	57222E3
	3300	30 x 40	3.3	6.3	0.79	0.27	57	41	17332E3	57332E3
	4700	35 x 40	3.8	7.2	1.13	0.38	48	35	17472E3	57472E3
	6800	35 x 50	4.7	8.9	1.64	0.55	36	27	17682E3	57682E3
	6800	40 x 40	4.1	7.8	1.64	0.55	45	33	n/a	47682E3
	10 000	40 x 50	4.9	9.3	2.40	0.80	35	27	17103E3	57103E3
	15 000	40 x 70	6.6	12.5	3.60	1.20	25	20	17153E3	57153E3
22 000	40 x 100	9.0	17.1	5.28	1.76	18	16	17223E3	57223E3	
63	1000	25 x 30	1.8	3.4	0.38	0.13	122	74	18102E3	58102E3
	1500	25 x 40	2.5	4.7	0.57	0.19	83	54	18152E3	58152E3
	2200	30 x 40	3.1	5.9	0.83	0.28	57	41	18222E3	58222E3
	3300	35 x 40	3.6	6.8	1.25	0.42	48	35	18332E3	58332E3
	4700	35 x 50	4.4	8.3	1.78	0.60	36	27	18472E3	58472E3
	4700	40 x 40	3.8	7.2	1.78	0.60	45	33	n/a	48472E3
	6800	40 x 50	4.7	8.9	2.57	0.86	35	27	18682E3	58682E3
	10 000	40 x 70	6.2	11.8	3.78	1.26	25	20	18103E3	58103E3
15 000	40 x 100	8.5	16.1	5.67	1.89	18	16	18153E3	58153E3	
100	470	25 x 30	1.4	2.7	0.28	0.10	247	172	19471E3	59471E3
	680	25 x 40	1.9	3.6	0.41	0.14	170	116	19681E3	59681E3
	1000	30 x 40	2.5	4.7	0.60	0.20	123	88	19102E3	59102E3
	1500	35 x 40	3.1	5.8	0.90	0.30	94	71	19152E3	59152E3
	2200	35 x 50	3.9	7.4	1.32	0.44	69	55	19222E3	59222E3
	2200	40 x 40	3.6	6.8	1.32	0.44	81	65	n/a	49222E3
	3300	40 x 50	4.6	8.7	1.98	0.66	59	48	19332E3	59332E3
	4700	40 x 70	6.2	11.7	2.82	0.94	42	36	19472E3	59472E3
6800	40 x 100	8.2	15.5	4.08	1.36	32	28	19682E3	59682E3	



Table 3

ELECTRICAL DATA AND ORDERING INFORMATION FOR 052 SERIES									
U _R (V)	C _R 100 Hz (µF)	NOMINAL CASE SIZE Ø D x L (mm)	I _R 100 Hz 85 °C (A)	I _R 20 kHz 70 °C (A)	I _{L1} 1 min (mA)	I _{L5} 5 min (mA)	ESR 100 Hz (mΩ)	Z 10 kHz (mΩ)	ORDERING CODE MAL2052.....
250	100	25 x 30	0.6	1.15	0.15	0.05	1800	1300	53101E3
	150	25 x 40	0.8	1.5	0.23	0.08	1100	850	53151E3
	220	30 x 40	1.0	1.9	0.33	0.11	750	550	53221E3
	330	35 x 40	1.4	2.65	0.49	0.17	500	400	53331E3
	470	35 x 50	1.8	3.4	0.70	0.24	360	290	53471E3
	470	40 x 40	1.8	3.4	0.70	0.24	420	350	43471E3
	680	40 x 50	2.3	4.4	1.02	0.34	250	190	53681E3
	1000	40 x 70	3.0	5.7	1.50	0.50	170	140	53102E3
385	47	25 x 30	0.5	0.94	0.11	0.04	2370	1550	58479E3
	68	25 x 40	0.67	1.27	0.16	0.06	1640	1100	58689E3
	100	30 x 40	0.84	1.59	0.23	0.08	1275	950	58101E3
	150	35 x 40	1.13	2.14	0.34	0.11	850	635	58151E3
	220	35 x 50	1.48	2.8	0.50	0.17	580	430	58221E3
	220	40 x 40	1.48	2.8	0.50	0.17	580	430	48221E3
	330	40 x 50	1.97	3.73	0.75	0.25	385	300	58331E3
	470	40 x 70	2.7	5.11	1.06	0.36	270	215	58471E3
400	47	25 x 30	0.47	0.89	0.11	0.04	2700	2125	56479E3
	68	25 x 40	0.63	1.29	0.16	0.06	1875	1470	56689E3
	100	30 x 40	0.84	1.59	0.24	0.08	1275	1000	56101E3
	150	35 x 40	1.13	2.14	0.36	0.12	850	665	56151E3
	220	35 x 50	1.41	2.67	0.52	0.17	650	450	56221E3
	220	40 x 40	1.41	2.67	0.52	0.17	650	450	46221E3
	330	40 x 50	1.86	3.52	0.79	0.26	435	315	56331E3
	470	40 x 70	2.54	4.81	1.12	0.37	305	225	56471E3
	680	40 x 100	3.56	6.75	1.63	0.54	210	155	56681E3

ADDITIONAL ELECTRICAL DATA		
PARAMETER	CONDITIONS	VALUE
Voltage		
Surge voltage	≤ 250 V versions	U _s = 1.15 x U _R
	≥ 385 V versions	U _s = 1.1 x U _R
Reverse voltage		U _{rev} ≤ 1 V
Current		
Leakage current	After 1 min at U _R	I _{L1} ≤ 0.006 C _R x U _R + 4 µA
	After 5 min at U _R	I _{L5} ≤ 0.002 C _R x U _R + 4 µA
Inductance		
Equivalent series inductance (ESL)	Case Ø D = 25 mm	Max. 25 nH
	Case Ø D = 30 mm and 35 mm	Max. 30 nH
	Case Ø D = 40 mm	Max. 35 nH



CAPACITANCE (C)



Fig. 11 - Typical multiplier of capacitance as a function of ambient temperature

EQUIVALENT SERIES RESISTANCE (ESR)

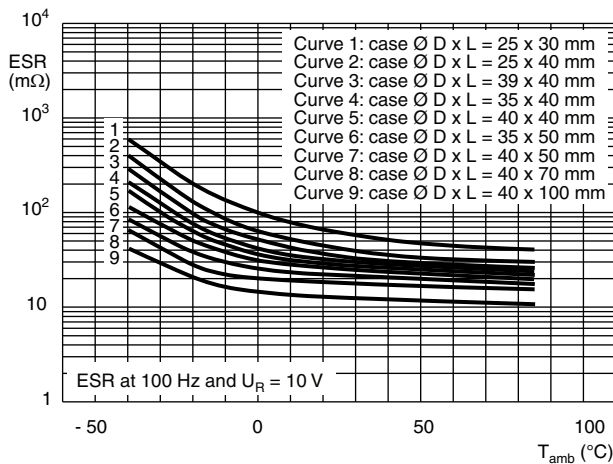


Fig. 12 - Typical ESR as a function of temperature

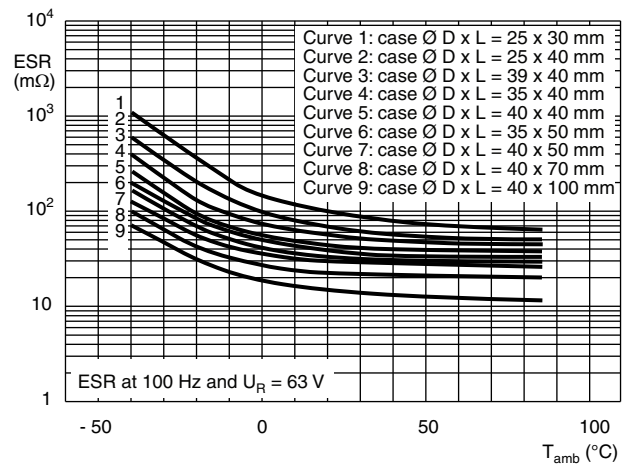


Fig. 13 - Typical ESR as a function of temperature

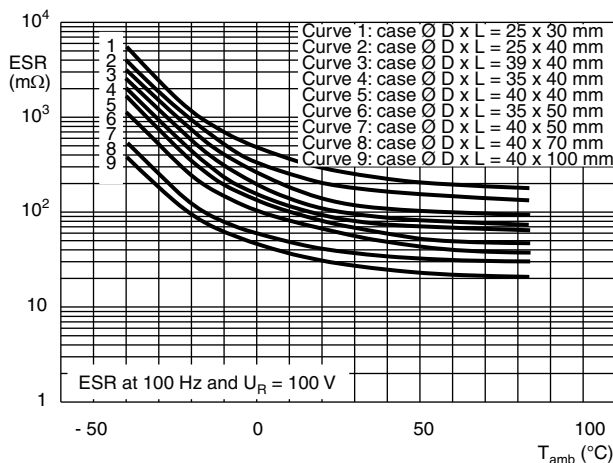


Fig. 14 - Typical ESR as a function of temperature

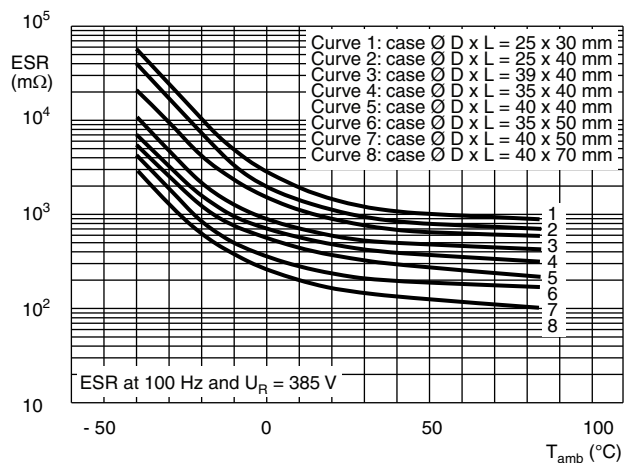


Fig. 15 - Typical ESR as a function of temperature



IMPEDANCE (Z)

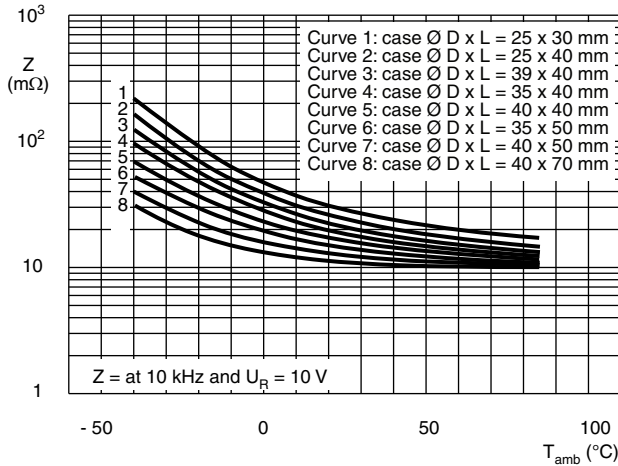


Fig. 16 - Typical impedance as a function of temperature

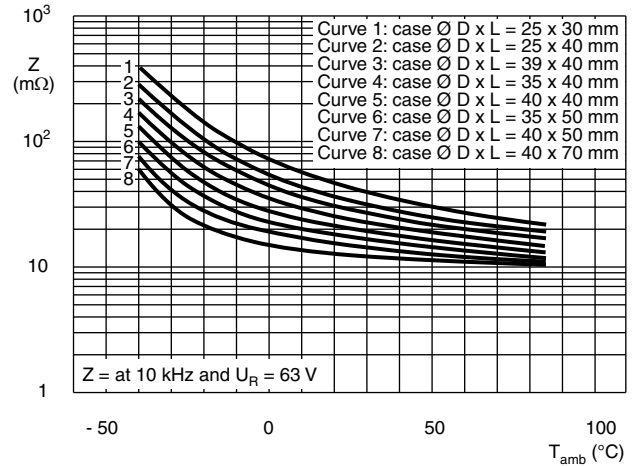


Fig. 17 - Typical impedance as a function of temperature

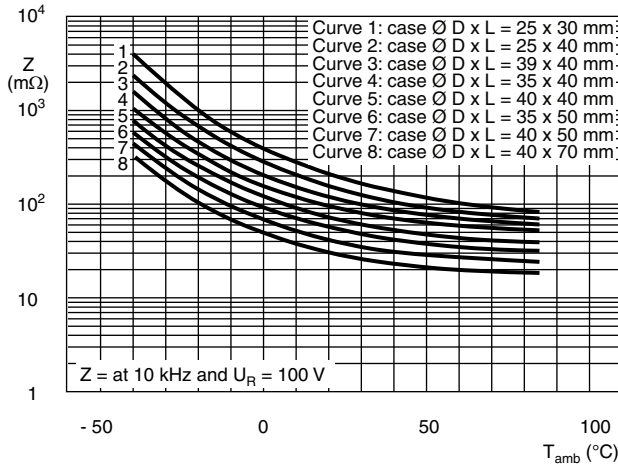


Fig. 18 - Typical impedance as a function of temperature

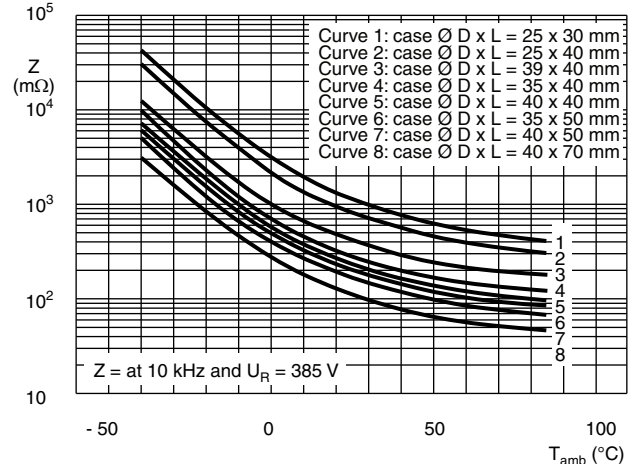


Fig. 19 - Typical impedance as a function of temperature

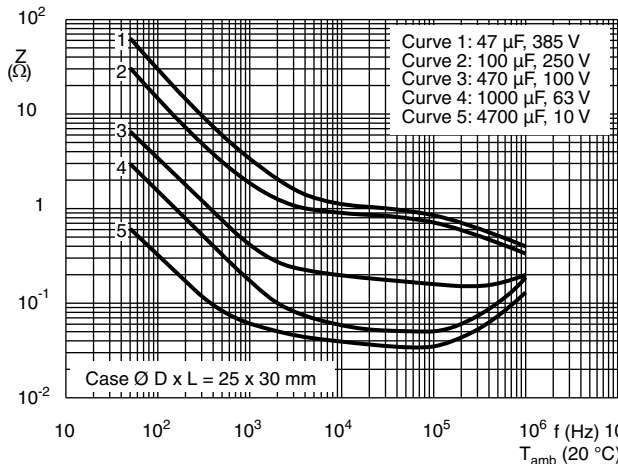


Fig. 20 - Typical impedance as a function of temperature

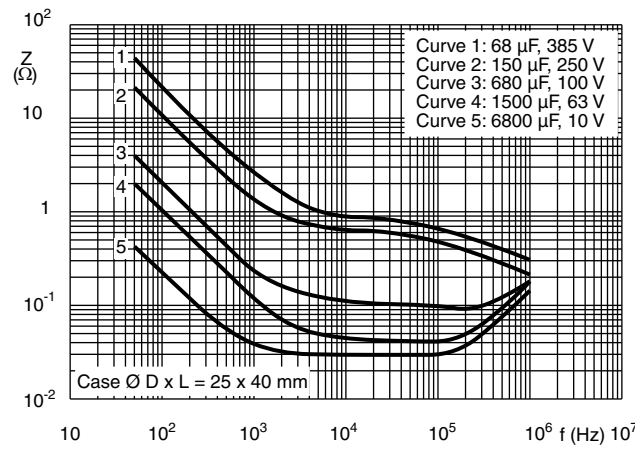


Fig. 21 - Typical impedance as a function of temperature



Fig. 22 - Typical impedance as a function of frequency

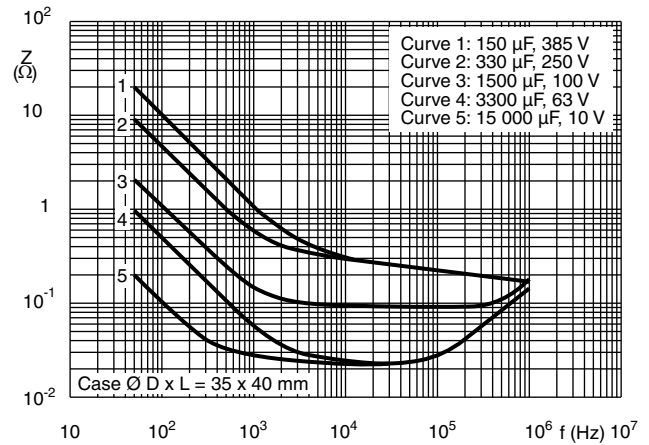


Fig. 23 - Typical impedance as a function of frequency

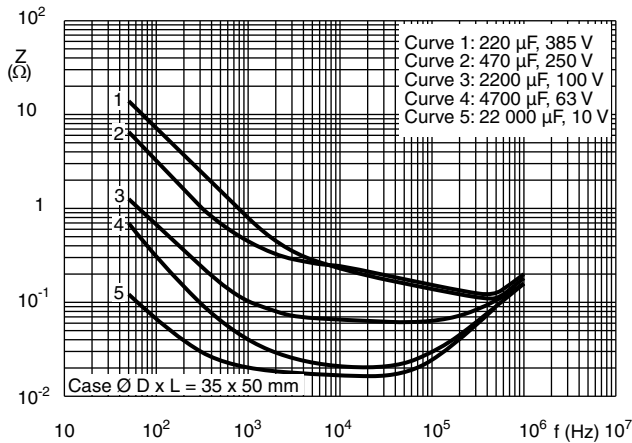


Fig. 24 - Typical impedance as a function of frequency

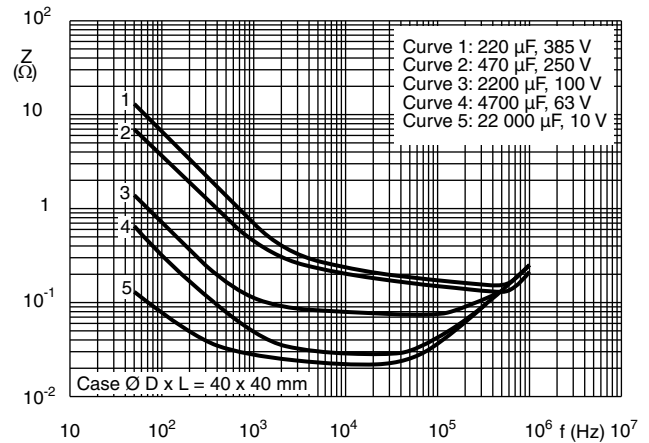


Fig. 25 - Typical impedance as a function of frequency

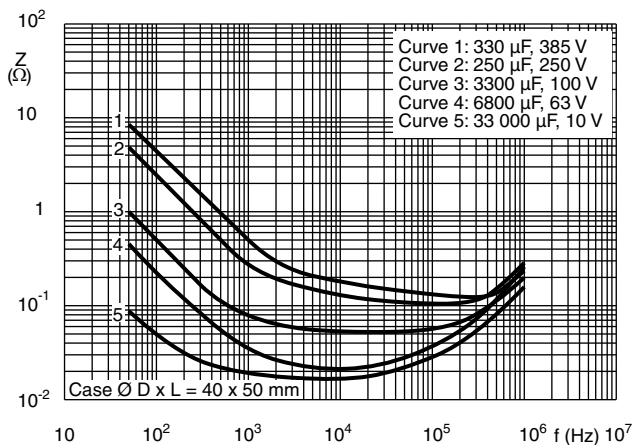


Fig. 26 - Typical impedance as a function of frequency

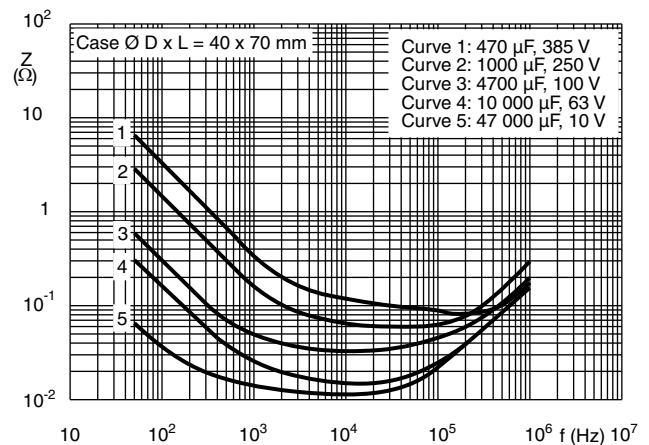


Fig. 27 - Typical impedance as a function of frequency

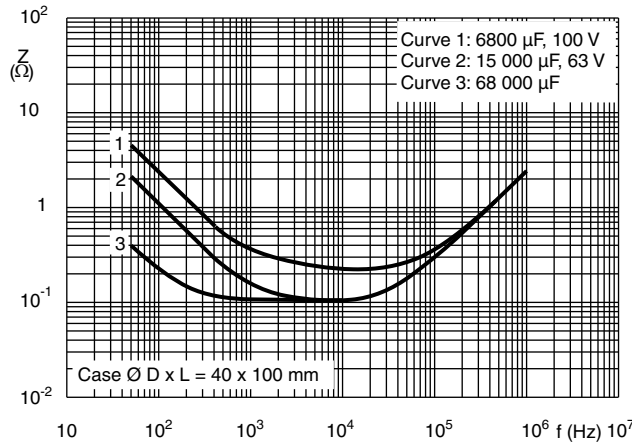


Fig. 28 - Typical impedance as a function of frequency

RIPPLE CURRENT AND USEFUL LIFE

Table 4

ENDURANCE TEST DURATION AND USEFUL LIFE	
ENDURANCE AT 85 °C (h)	USEFUL LIFE AT 85 °C (h)
5000	15 000

Note

- Multiplier of useful life code: MGA453



I_A = Actual ripple current
 I_R = Rated ripple current at 100 Hz and 85 °C
 (1) Useful life at 85 °C and I_R applied: 15 000 h

Fig. 29 - Multiplier of useful life as a function of ambient temperature and ripple current load



Table 5

MULTIPLIER OF RIPPLE CURRENT (I_R) AS A FUNCTION OF FREQUENCY					
FREQUENCY (Hz)					
50	100	200	400	1000	≥ 2000
I_R MULTIPLIER					
0.83	1.00	1.10	1.15	1.19	1.20

Table 6

TEST PROCEDURES AND REQUIREMENTS			
TEST		PROCEDURE (QUICK REFERENCE)	REQUIREMENTS
NAME OF TEST	REFERENCE		
Endurance	IEC 60384-4 / EN 130300 subclause 4.13	$T_{amb} = 85\text{ °C}$; U_R applied; 5000 h	$U_R \leq 100\text{ V}$; $\Delta C/C: \pm 15\%$ $U_R > 100\text{ V}$; $\Delta C/C: \pm 10\%$ $ESR \leq 1.3 \times \text{spec. limit}$ $Z \leq 2 \times \text{spec. limit}$ $I_{L5} \leq \text{spec. limit}$
Useful life	CECC 30301 subclause 1.8.1	$T_{amb} = 85\text{ °C}$; U_R and I_R applied; 15 000 h	$U_R \leq 100\text{ V}$; $\Delta C/C: \pm 45\%$ $U_R > 100\text{ V}$; $\Delta C/C: \pm 30\%$ $ESR \leq 3 \times \text{spec. limit}$ $Z \leq 3 \times \text{spec. limit}$ $I_{L5} \leq \text{spec. limit}$ no short or open circuit, no visible damage total failure percentage: $U_R \leq 100\text{ V}: \leq 1\%$; $U_R > 100\text{ V}: \leq 3\%$
Shelf life (storage at high temperature)	IEC 60384-4 / EN 130300 subclause 4.17	$T_{amb} = 85\text{ °C}$; no voltage applied; 500 h After test: U_R to be applied for 30 min, 24 h to 48 h before measurement	$\Delta C/C: \pm 10\%$ $ESR \leq 1.2 \times \text{spec. limit}$ $I_{L5} \leq 2 \times \text{spec. limit}$

Statements about product lifetime are based on calculations and internal testing. They should only be interpreted as estimations. Also due to external factors, the lifetime in the field application may deviate from the calculated lifetime. In general, nothing stated herein shall be construed as a guarantee of durability.



Disclaimer

ALL PRODUCT, PRODUCT SPECIFICATIONS AND DATA ARE SUBJECT TO CHANGE WITHOUT NOTICE TO IMPROVE RELIABILITY, FUNCTION OR DESIGN OR OTHERWISE.

Vishay Intertechnology, Inc., its affiliates, agents, and employees, and all persons acting on its or their behalf (collectively, "Vishay"), disclaim any and all liability for any errors, inaccuracies or incompleteness contained in any datasheet or in any other disclosure relating to any product.

Vishay makes no warranty, representation or guarantee regarding the suitability of the products for any particular purpose or the continuing production of any product. To the maximum extent permitted by applicable law, Vishay disclaims (i) any and all liability arising out of the application or use of any product, (ii) any and all liability, including without limitation special, consequential or incidental damages, and (iii) any and all implied warranties, including warranties of fitness for particular purpose, non-infringement and merchantability.

Statements regarding the suitability of products for certain types of applications are based on Vishay's knowledge of typical requirements that are often placed on Vishay products in generic applications. Such statements are not binding statements about the suitability of products for a particular application. It is the customer's responsibility to validate that a particular product with the properties described in the product specification is suitable for use in a particular application. Parameters provided in datasheets and / or specifications may vary in different applications and performance may vary over time. All operating parameters, including typical parameters, must be validated for each customer application by the customer's technical experts. Product specifications do not expand or otherwise modify Vishay's terms and conditions of purchase, including but not limited to the warranty expressed therein.

Except as expressly indicated in writing, Vishay products are not designed for use in medical, life-saving, or life-sustaining applications or for any other application in which the failure of the Vishay product could result in personal injury or death. Customers using or selling Vishay products not expressly indicated for use in such applications do so at their own risk. Please contact authorized Vishay personnel to obtain written terms and conditions regarding products designed for such applications.

No license, express or implied, by estoppel or otherwise, to any intellectual property rights is granted by this document or by any conduct of Vishay. Product names and markings noted herein may be trademarks of their respective owners.